

Hotte Mezzo® haut 500

Hotte Mezzo® haut 500

- Hotte Mezzo® haut 500 double
- Hotte four

Débit en m³/h	Hotte Mezzo® haut 500		Hotte Mezzo® haut 500 double	
	Hotte Mezzo® haut 500	Hotte Mezzo® haut 500 double	Hotte Mezzo® haut 500	Hotte Mezzo® haut 500 double
1 000	2	0	4	0
1 500	2	1	4	2
2 000	2	2	4	4
2 500	3	2	6	4
3 000	3	3	6	6
3 500	4	3	8	6
4 000	4	4	8	8
4 500	5	4	10	8
5 000	5	5	10	10
5 500	6	5	12	10
6 000	6	6	12	12

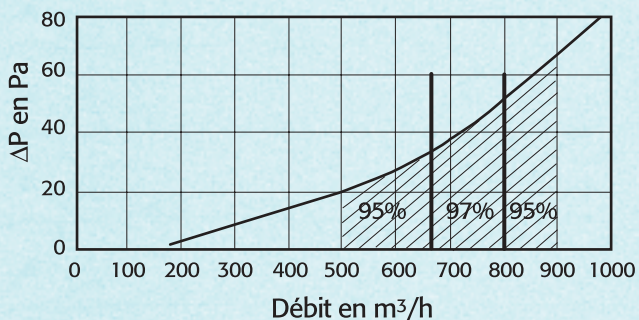

Zone grisée : débit optimum de filtration.

Hotte Mezzo® haut 500 double
Hotte four

Hotte Mezzo® haut 500

- Hotte Mezzo® haut 500 double
- Hotte four

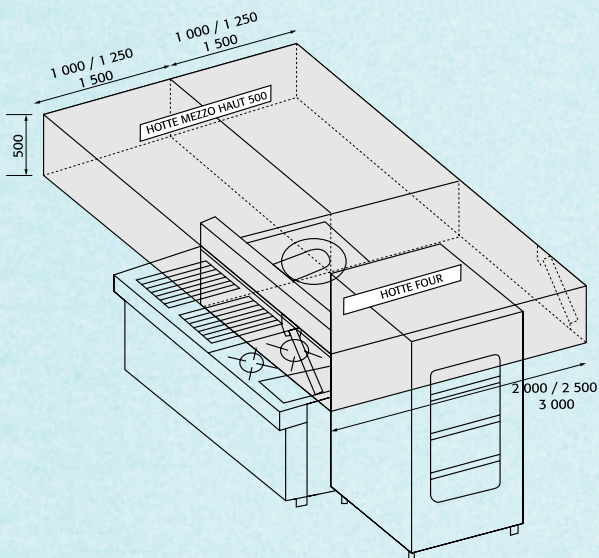

Hotte Mezzo® haut 500

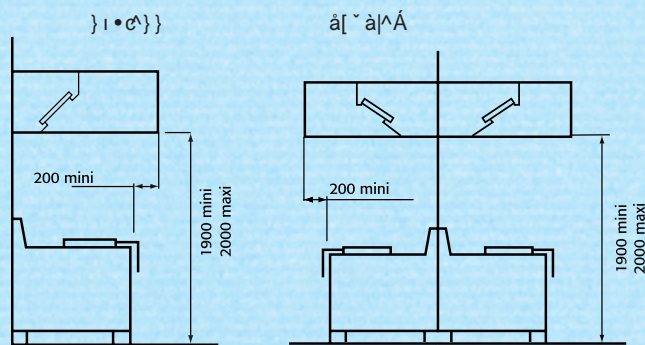

Hotte Mezzo® haut 500

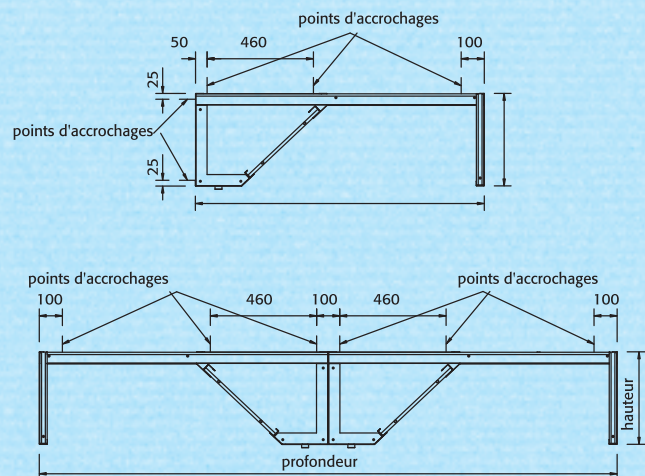

plan de principe des hottes mezzo

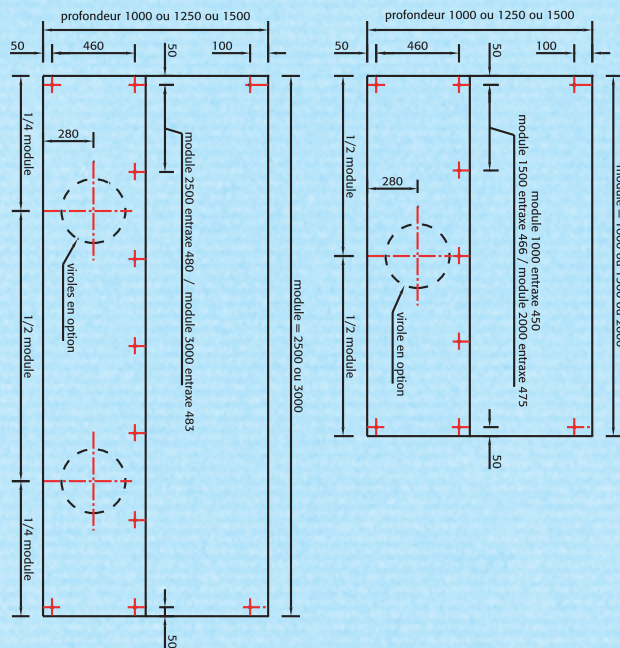

Hotte Mezzo® haut 500 double
Hotte four

Hotte Mezzo® haut 500

] |ö|~ z^} •cc[Á^::[

► Áæ | [ç. Á • ç^q^ } a ÁÚ

- ① Áæ | æ ~ b Á : } a ~ Á | • } ö
- ② Áæ | æ ~ b Á • | a : æ ã Á æ q [ç
- ③ Áæ | . Á æ ç } a

• ÁÚ • ç^q^ } a ÁÚ Á

- Ä | a @æ } Á æ |
- Ä æ | Á gá : 0æ
- Ä | a [b } a Á æ G H E
- Ä | [: æ Ö Á Á ö | [Á æ è ç
- IP 54.
- Ä | : { Á ^ Á
- ç z æ Á Á Á { Á F Á G H I Y D E Á { Á F c F I Y D E
- z ð æ Ö Á Á Á { Á F Á G H I D E Á { Á F c F I Y D E
- á 0 æ Ö Á Á Á { Á F Á G H I Y D E Á { Á F c F I Y D E

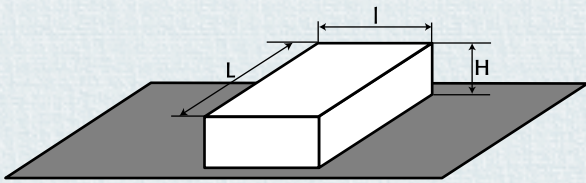
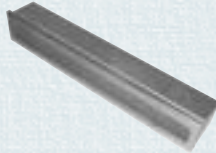

► Á [] \ æ z æ } | • \ æ Á

- Á æ ^ :] ^ ~ b Á ^ ç [• È
- Á

c Á [[á æ á b á) | ç ^ Á

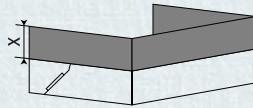

► Ö ä ^ Á æ • } ^ } æ Á

- Á æ æ ^ Á ^ ~
- Ä g } [• Á Á Á È
- Ä | a q \ Á á Á æ Á Á æ Á H D E
- Ä | : { Á ^ Á Á H Á Á Á Á Á { È



• Á • } ^ } a

- Ä | : { Á ^ Á Á H Á Á Á Á Á { È
- Ä @ g a æ Á Á { È

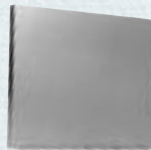

► ÁÚ | a æ Á æ Á

- ÁÚ | a æ Á æ Á æ • } ^ } ö
- < Á F I Ä H I Ä È È

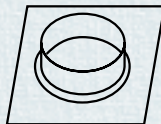

► Á | [á Á

- Á | ^ @ ç Ä
- Á | [á Á ^ ~ | | æ a [Á
- ç) g d æ æ æ æ

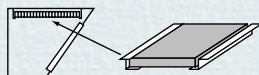

Ä |ö|~ z^} •cc[

► ÁÚ | a [b } a Á

- Á á ç [á) Á [| \ q : Á æ } [á ^ & @ Á
- ç z æ Á Á Á Á { Á æ ð æ Á Á Á Á { È

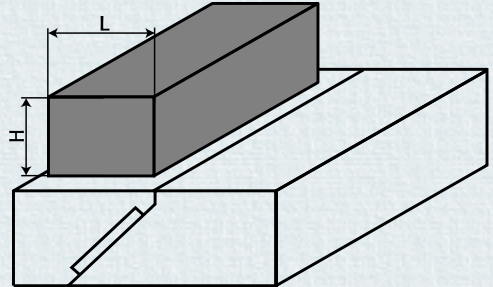

- Á á ç [á) Á [| \ q : Á æ } [á ^ & @ Á
- ç z æ Á Á Á Á { Á æ ð æ Á Á Á Á { È

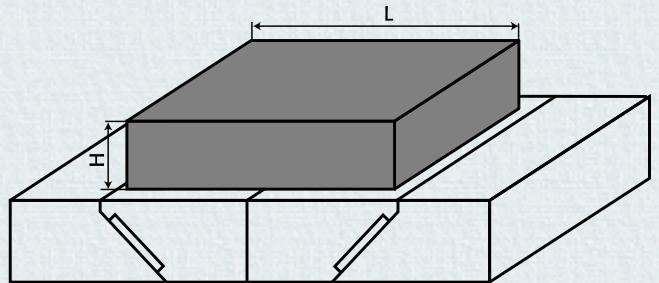

- Á á ç [á) Á [| \ q : Á æ } [á ^ & @ Á
- ç z æ Á Á Á Á { Á æ ð æ Á Á Á Á { È

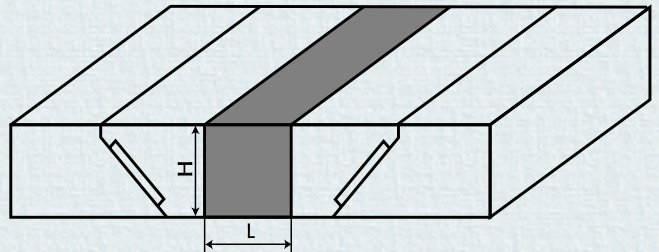

Ú!•[] ää | &äá ÁÁ ^::[

>Äöä ^•q !^ >Ä^•[\ Á[{ } ic

- Á[]: ~|c äÄÄ ä ä

>ÄÜ[@ç Ää ^•q !

- Ä @|ÄÜ €»

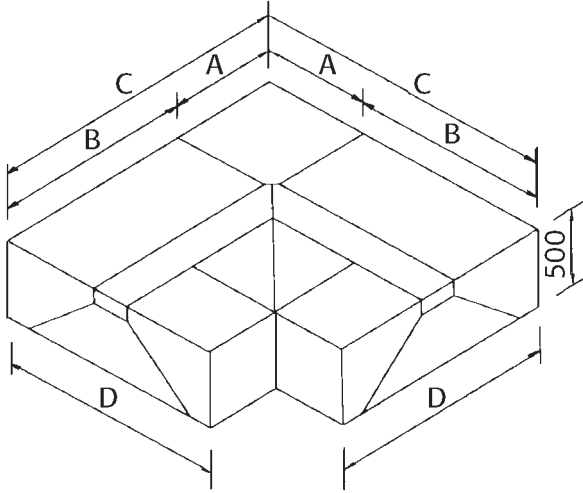

Q. Ä^ \ [•ä @ [çÁ [] : ~|c äÄÄ ä ä

$C = A + B$

Äöä	ÄÜ [D	ÄÜ [D	ÄÜ [D
1000	600	1000	1600
1250	600	1000	1600
1500	600	1000	1600

Ú!•[] ää | &äá ÁÁ ^::[

>ÄÜ[^&@ÄÄ ^@ä: ä^Ä &^Ä &^Ä

- Ä[^Ä) Ä

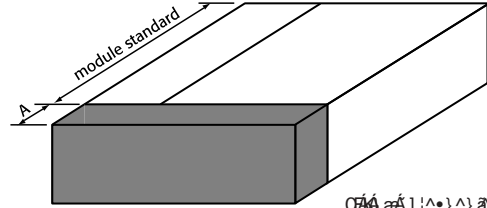

Q. Ä^ \ [•ä @ [çÁ [] : ~|c äÄÄ ä ä

- Ä ää) Ä

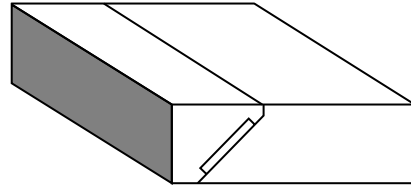

- Ä @ []

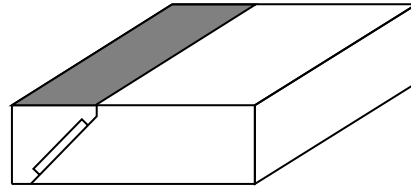

Ú! çä ÄÜ ä | ÄÜ & ^ÄÄ []

Ü^•[\] ää | &ää Á^•: [Á[{ } ^] •ää

> Ü^•[\] ää | &ää Á^•: [Á[{ } ^] •ää

- Ää ää Á^•: [Á[{ } ^] •ää

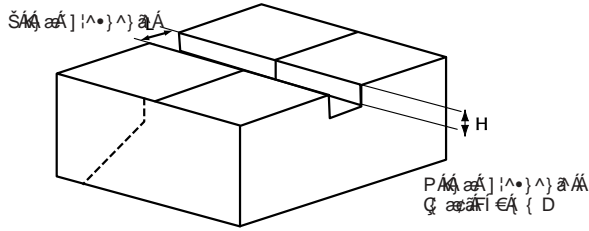

> Ü^•[\] ää | &ää Á^•: [Á[{ } ^] •ää

- Ää ää Á^•: [Á[{ } ^] •ää

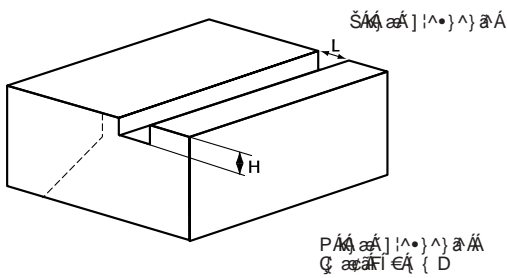

> Ä^•[\] ää | &ää Á^•: [Á[{ } ^] •ää

- Ää ää Á^•: [Á[{ } ^] •ää

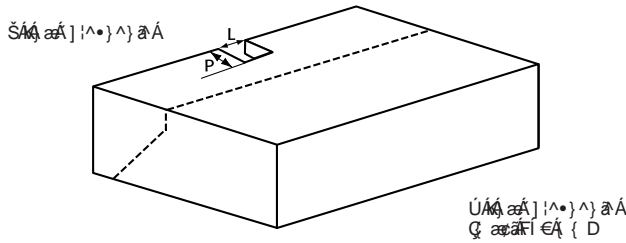

* Á[{ } ^] •ää | &ää Á^•: [Á[{ } ^] •ää

> Á[{ } ^] •ää | &ää Á^•: [Á[{ } ^] •ää

- Ä^•[\] ää | &ää Á^•: [Á[{ } ^] •ää

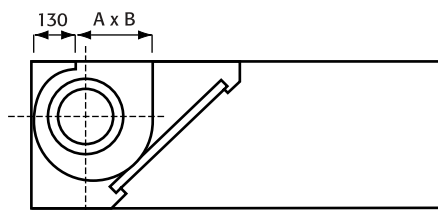
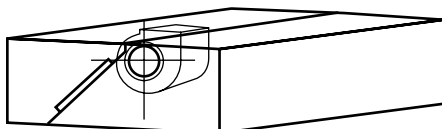

Ü^•[\] ää | &ää Á^•: [Á[{ } ^] •ää

> Öä^•q i^ >Ä^•[\ Á[{ } ^] •ää

- Ää ää Á^•: [Á[{ } ^] •ää

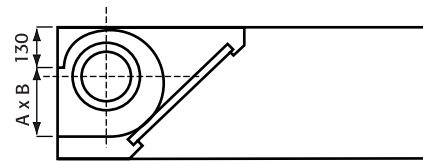
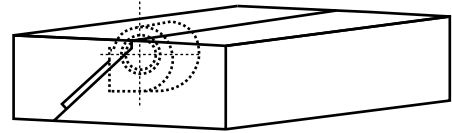

c] Ää	Öäq { D	Äöq { D	Ää z] ää
7.7.4	200	233	400
7.9.4	210	300	400 / 500
9.9.4	265	300	500

> Öä^•q i^ >Ä^•[\ Á[{ } ^] •ää

- Ä^•[\] ää | &ää Á^•: [Á[{ } ^] •ää

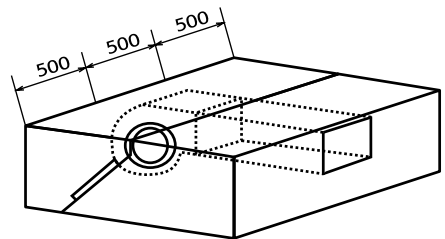

- Á[{ } ^] •ää | &ää Á^•: [Á[{ } ^] •ää

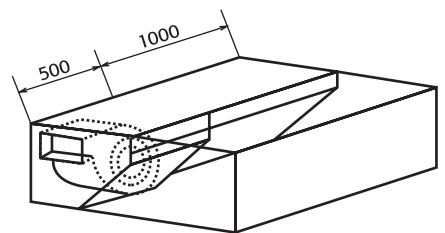

Ü^•[\] ää | &ää Á^•: [Á[{ } ^] •ää

Öa^•q i^Á

► Öa^•q i^Á

- ① Á [•] i Á c) ã i^Á c i^Á
- ② Á i & @ Á & [ç Á i & @
- ③ Á ã ã ^ Á ^ \ É g ã } [• Á i Á É
- ④ Á i q ã i Á i) ã ã
- ⑤ Á i d ^ á [ç i Á 5) ã ã
- ⑥ Á i ^ @ ç. Á • ç d ^) ã Á i É ã } ^ Á c Á Á É
- ⑦ Á i ^ @ á: ã ^ g ã i ã i d i É
- ⑧ Á i & [ç i Á] : [ã ã
- ⑨ Á i ^ c. { Á ã ã ç i á: ã ã Á [} á ^) : i d ç ã

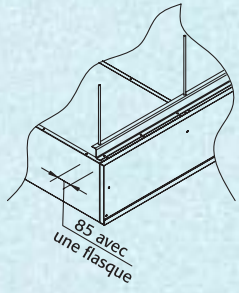
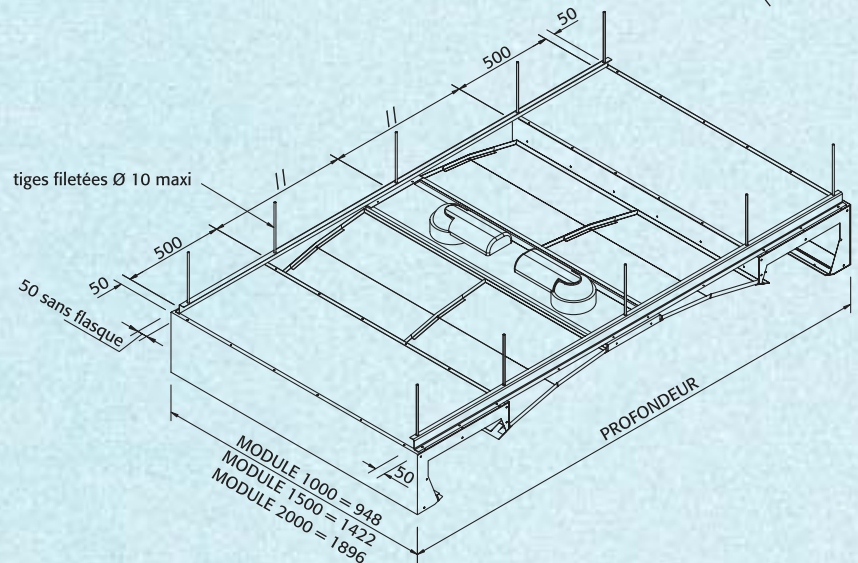
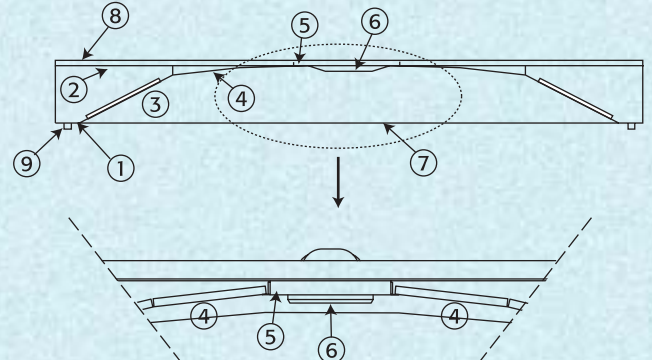

► Á i ^ Á

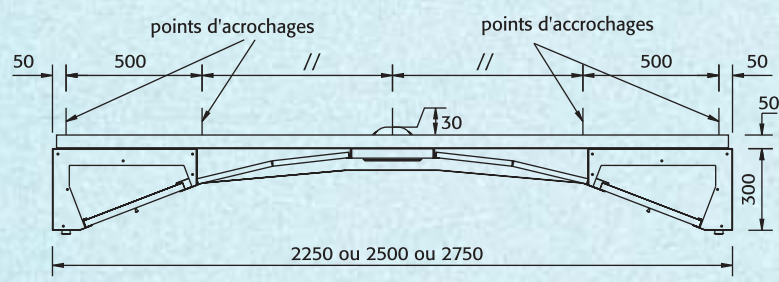

Montage encastré

Montage en applique

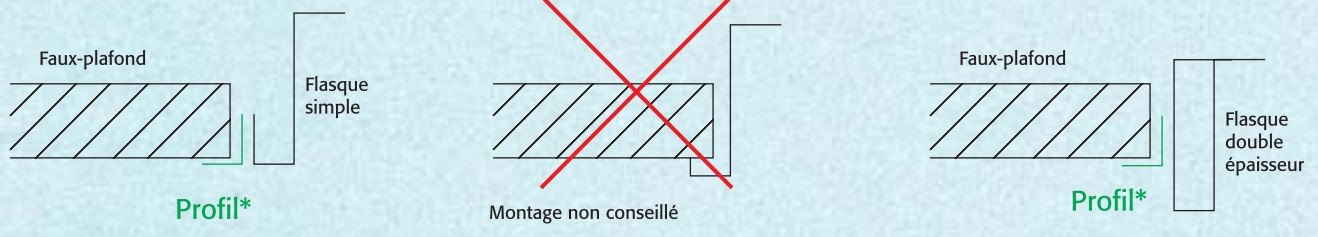

* Profil non fourni ; raccordement à la flasque par rivets.

Äöä [] ä

► Äöä ^ d ^ Spacio®

• Spacio® Äöä Ä d [] gÄ [] o Äöä Ä [ä @ ää D Ä ä ä Äöä Ä []

P ä ä ä Äöä Ä []

P ä ä ä Äöä Ä []

Äöä [] gÄ []	Äöä Ä []	U • gÄ d ^ ä	Äöä Ä [] gÄ []
1 966 x 2 250	103	2	8
2 440 x 2 250	141	3	10
2 914 x 2 250	160	4	12
3 388 x 2 250	177	4	14
3 862 x 2 250	194	4	16
4 336 x 2 250	234	6	18
4 810 x 2 250	251	6	20
5 284 x 2 250	268	6	22
5 788 x 2 250	285	6	24
6 232 x 2 250	325	8	26
6 706 x 2 250	342	8	28
7 180 x 2 250	359	8	30
7 684 x 2 250	375	8	32
8 128 x 2 250	416	10	34
8 602 x 2 250	433	10	36
9 076 x 2 250	449	10	38
9 560 x 2 250	466	10	40
10 074 x 2 250	507	12	42
10 498 x 2 250	523	12	44
10 972 x 2 250	540	12	46

Äöä [] gÄ []	Äöä Ä []	U • gÄ d ^ ä	Äöä Ä [] gÄ []
1 966 x 2 500	109	2	8
2 460 x 2 500	150	3	10
2 914 x 2 500	170	4	12
3 388 x 2 500	188	4	14
3 862 x 2 500	205	4	16
4 336 x 2 500	249	6	18
4 810 x 2 500	266	6	20
5 284 x 2 500	284	6	22
5 758 x 2 500	301	6	24
6 232 x 2 500	345	8	26
6 706 x 2 500	362	8	28
7 180 x 2 500	380	8	30
7 654 x 2 500	398	8	32
8 128 x 2 500	441	10	34
8 602 x 2 500	459	10	36
9 076 x 2 500	476	10	38
9 560 x 2 500	494	10	40
10 024 x 2 500	537	12	42

Äöä [] gÄ []	Äöä Ä []	U • gÄ d ^ ä	Äöä Ä [] gÄ []
1 966 x 2 750	115	2	8
2 440 x 2 750	159	3	10
2 914 x 2 750	180	4	12
3 388 x 2 750	198	4	14
3 862 x 2 750	217	4	16
4 316 x 2 750	264	6	18
4 810 x 2 750	282	6	20
5 284 x 2 750	300	6	22
5 758 x 2 750	318	6	24
6 262 x 2 750	366	8	26
6 706 x 2 750	384	8	28
7 180 x 2 750	402	8	30
7 654 x 2 750	420	8	32
8 128 x 2 750	467	10	34
8 532 x 2 750	486	10	36
9 076 x 2 750	504	10	38

Äöä

• Spacio® Äöä Ä d [] gÄ [] o Äöä Ä [ä @ ää D Ä ä ä Äöä Ä []

► U • [] gÄ [] o Äöä Ä [ä @ ää D Ä ä ä Äöä Ä []

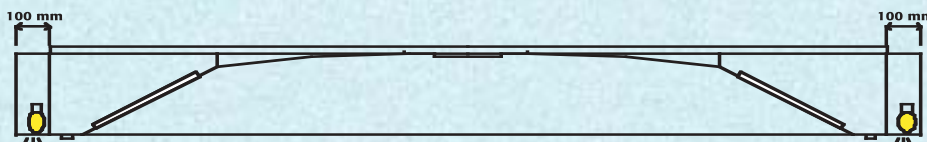

• Spacio® Äöä Ä d [] gÄ [] o Äöä Ä [ä @ ää D Ä ä ä Äöä Ä []

P ä ä ä Äöä Ä []

P ä ä ä Äöä Ä []

Äöä [] gÄ []	Äöä Ä []	U • gÄ d ^ ä	Äöä Ä [] gÄ []
1 966 x 2 450	127	2	8
2 440 x 2 450	173	3	10
2 914 x 2 450	198	4	12
3 388 x 2 450	219	4	14
3 862 x 2 450	240	4	16
4 336 x 2 450	290	6	18
4 810 x 2 450	311	6	20
5 284 x 2 450	332	6	22
5 758 x 2 450	353	6	24
6 232 x 2 450	403	8	26
6 706 x 2 450	424	8	28
7 180 x 2 450	445	8	30
7 654 x 2 450	466	8	32
8 128 x 2 450	517	10	34
8 602 x 2 450	538	10	36
9 076 x 2 450	559	10	38
9 550 x 2 450	580	10	40
10 024 x 2 450	630	12	42
10 498 x 2 450	651	12	44
10 972 x 2 450	672	12	46

Äöä [] gÄ []	Äöä Ä []	U • gÄ d ^ ä	Äöä Ä [] gÄ []
1 966 x 2 700	133	2	8
2 440 x 2 700	182	3	10
2 914 x 2 700	208	4	12
3 388 x 2 700	229	4	14
3 862 x 2 700	251	4	16
4 336 x 2 700	305	6	18
4 810 x 2 700	326	6	20
5 284 x 2 700	348	6	22
5 758 x 2 700	370	6	24
6 232 x 2 700	423	8	26
6 706 x 2 700	445	8	28
7 180 x 2 700	467	8	30
7 654 x 2 700	489	8	32
8 128 x 2 700	542	10	34
8 602 x 2 700	564	10	36
9 076 x 2 700	585	10	38
9 550 x 2 700	607	10	40
10 024 x 2 700	661	12	42

Äöä [] gÄ []	Äöä Ä []	U • gÄ d ^ ä	Äöä Ä [] gÄ []
1 966 x 2 950	138	2	8
2 440 x 2 950	191	3	10
2 914 x 2 950	218	4	12
3 388 x 2 950	240	4	14
3 862 x 2 950	263	4	16
4 336 x 2 950	319	6	18
4 810 x 2 950	342	6	20
5 284 x 2 950	365	6	22
5 758 x 2 950	387	6	24
6 232 x 2 950	444	8	26
6 706 x 2 950	466	8	28
7 180 x 2 950	489	8	30
7 654 x 2 950	511	8	32
8 128 x 2 950	568	10	34
8 602 x 2 950	590	10	36
9 076 x 2 950	613	10	38

Äöä

• Spacio® : Äöä Ä d [] gÄ [] o Äöä Ä [ä @ ää D Ä ä ä Äöä Ä []

SPACIO®

